

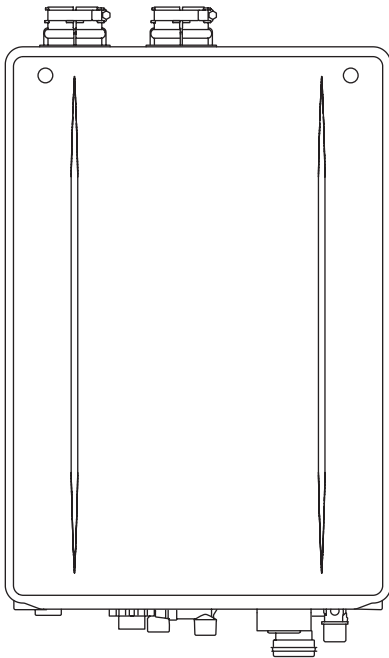

# Owner's Guide

## CONDENSING TANKLESS GAS WATER HEATER

### Model : NCC199CDV (GQ-C3260WZ-FF US)



Thank you for purchasing this Noritz Tankless Gas Water Heater. Before using:

- Read this manual completely for operation instructions.
- To ensure full coverage by the Noritz America Corporation Limited Warranty service, see the warranty registration information (page 33), and then visit the Noritz website ([www.noritz.com/warranty](http://www.noritz.com/warranty)) to register your product.
- Keep this manual where it can be found whenever necessary because the warranty registration information is included. (See page 33)

Installation must conform with local codes, or in the absence of local codes, the National Fuel Gas Code, ANSI Z223.1 / NFPA 54 - latest edition and/or the Natural Gas and Propane Installation Code CSA B149.1- latest edition.

When applicable, installation must conform with the Manufactured Home Construction and Safety Standard, Title 24 CFR, Part 3280 or the Canadian Standard CAN/CSA-Z240 MH Mobile Homes, Series M86.

Noritz America reserves the right to discontinue, or change at any time, the designs and/or specifications of its products without notice.

FOR USE IN COMMERCIAL OR MANUFACTURED HOME APPLICATIONS.

#### **⚠ WARNING**

If the information in this manual is not followed exactly, a fire or explosion may result causing property damage, personal injury or death.

- **Do not store or use gasoline or other flammable vapors and liquids in the vicinity of this or any other appliance.**
- **WHAT TO DO IF YOU SMELL GAS**
  - Do not try to light any appliance.
  - Do not touch any electrical switch; do not use any phone in your building.
  - Immediately call your gas supplier from a neighbor's phone. Follow the gas supplier's instructions.
  - If you cannot reach your gas supplier, call the fire department.
- **Installation and service must be performed by a qualified installer, service agency or the gas supplier.**



Low NOx Approved by SCAQMD  
14 ng/J or 20 ppm  
(Natural Gas Only)





# Important Safety Information

To prevent damage to property and injury to the user, the icons shown below will be used to warn of varying levels of danger.

Every indication is critical to the safe operation of the Water Heater and must be understood and observed. Potential dangers from accidents during installation and use are divided into the following four categories. Closely observe these warnings; they are critical to your safety.

## Icons warning of risk level

 This is the safety alert symbol. It is used to alert you to potential personal injury hazards. Obey all safety messages that follow this symbol to avoid possible injury or death.

 **DANGER** Indicates an imminently hazardous situation which, if not avoided, will result in death or serious injury.

 **WARNING** Indicates a potentially hazardous situation which, if not avoided, could result in death or serious injury.

 **CAUTION** Indicates a potentially hazardous situation which, if not avoided, may result in minor or moderate injury.

 **NOTICE** Indicates a potentially hazardous situation which, if not avoided, may result in property damage.

### **DANGER**

**Vapors from flammable liquids will explode and catch fire causing death or severe burns.**

Do not use or store flammable products such as gasoline, solvents or adhesives in the same room or area near the Water Heater.



**Keep flammable products:**

1. Far away from the Water Heater.
2. In approved containers.
3. Tightly closed.
4. Out of children's reach.

**Vapors:**

1. Cannot be seen.
2. Vapors are heavier than air.
3. Go a long way on the floor.
4. Can be carried from other rooms to the main burner by air currents.

After the Water Heater has been out of use for a long time make sure that you fill the condensate trap with water.

This is to prevent dangerous exhaust gases from entering the building.

Failure to fill the condensate trap could result in severe personal injury or death.

(Refer to page 24 for further instructions.)

**Hot Water Heater temperatures over 125°F (52°C) can cause severe burns instantly or death from scalding.**

Children, disabled and elderly are at the highest risk of being scalded.

Feel water temperature before bathing or showering. Temperature limiting valves are available, consult with installer.

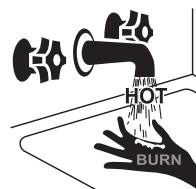

**Do not use the Water Heater if the intake/exhaust pipe is displaced, has holes, is clogged or is corroded.**

**This will cause carbon monoxide poisoning and a potential fire hazard.**

**Do not allow anyone to change the water temperature while hot water is being used.**

To prevent scalding, do not change the water temperature to a higher setting.

**[When supplying combustion air from the indoors]**

**Check whether or not the air supply vent is blocked with dust, trash, a towel, or the like.**

Blocking the opening may result in incomplete combustion.

## **⚠ WARNING**

- A. This Water Heater does not have a pilot. It is equipped with an ignition device that automatically lights the burner. Do not try to light the burner by hand.
- B. BEFORE OPERATING smell all around the Water Heater area for evidence of leaking gas. Be sure to smell next to the floor because some gas is heavier than air and will settle on the floor.
- WHAT TO DO IF YOU SMELL GAS**
- Do not try to light any appliance.
  - Do not touch any electrical switch; do not use any phone in your building.
  - Immediately call your gas supplier from a neighbor's phone. Follow the gas supplier's instructions.
  - If you cannot reach your gas supplier, call the fire department.
- C. Use only your hand to turn the gas valve knob. Never use tools. If the knob will not turn by hand, don't try to repair it. Call a qualified service technician. Force or attempted repair may result in a fire or explosion.
- D. Do not use this Water Heater if any part has been under water. Immediately call a qualified service technician to inspect the Water Heater and to replace any damaged parts.

When a gas leak is noticed:

1. Stop use immediately.
2. Close the gas valve.

[Indoor Installation]

3. Open windows and doors.

If you detect abnormal combustion or abnormal odors, or during an earthquake, tornado or fire:

1. Turn off the hot water supply.
2. Turn off the power to the Water Heater.
3. Turn off gas and water supply valves.
4. Call the nearest Noritz agent.

**Explosion Hazard;**

If the temperature and pressure relief valve is dripping or leaking, have a qualified service technician replace it. Do not plug or remove the valve.

Failure to follow these instructions can result in fire or explosion, and personal injury or death.

Check the temperature of the running hot water before entering the shower.

Check the temperature before stepping into the bathtub.

To prevent burns or scalding, turn off the Power button and wait until the appliance cools before performing maintenance.

Do not place the exhaust vent terminal in an indoor environment by means of adding walls and ceiling (Do not enclose using corrugated sheets, etc.).

Carbon monoxide poisoning or fire may occur as a result.

Leave the proper clearance between the Water Heater and nearby objects (trees, timber, boxes with flammable materials, etc.).

[Indoor Installation]

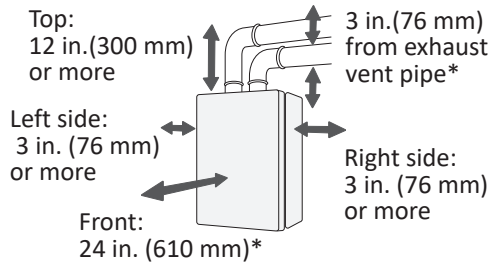

[Outdoor Installation]

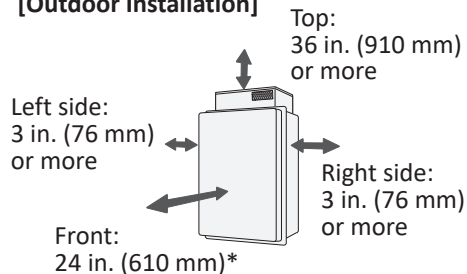

\*Indicates suggested clearances for maintenance.

Do not place combustibles such as laundry, newspapers, oils etc. near the heater or the exhaust vent terminal.

Do not install this Water Heater in a recreational vehicle or on a boat as this may be a Carbon Monoxide Poisoning Hazard. Do not install this Water Heater in a mobile home when using SV conversion kit ("SV" configuration).

Do not use combustible chemicals such as oil, gasoline, benzene etc. in the near the heater or the exhaust vent terminal.

Do not store or use gasoline or other flammable vapors and liquids in the vicinity of this or any other appliance.

Do not place or use a spray can near the Water Heater or the exhaust vent terminal.

## **⚠ WARNING**

Be sure the gas/power supplied matches “Type of Gas” and “Electrical Rating” on the rating plate.

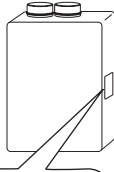

(e.g. NCC199CDV (GQ-C3260WZ-FF US))

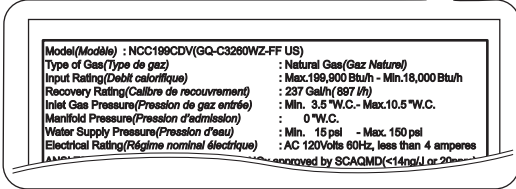

Installation and service must be performed by a qualified installer, service agency or the gas supplier.

Consult the nearest Noritz agent if the Water Heater location needs to be changed.

If this appliance will be installed in a beauty salon or other location where hair spray or aerosols will be used, locate the appliance in a separate area that is supplied with fresh air from outdoors.

Do not use hair spray or spray detergent in the vicinity of the appliance.

Avoid installation in places where dust or debris will accumulate.  
Dust may accumulate and reduce the performance of the unit's fan.  
This can result in incomplete combustion.

[When supplying combustion air from the indoors]  
Check the air supply opening for dust or obstructions.

To prevent injury or death, do not allow small children to bathe or play in the bathroom unsupervised.

Do not touch the power cord with wet hands.



Contact a qualified service technician for any necessary repairs, service or maintenance.

Do not use parts other than those specified for this appliance.

California Proposition 65 lists chemical substances known to the state to cause cancer, birth defects, death, serious illness or other reproductive harm. This product may contain such substances, be their origin from fuel combustion (gas, oil) or components of the product itself.

The gas conversion kit shall be installed by a qualified service agency in accordance with the manufacturer's instructions and all applicable codes and requirements of the authority having jurisdiction. The information in the instructions must be followed to minimize the risk of fire or explosion or to prevent property damage, personal injury, or death. The qualified service agency is responsible for the proper installation of this kit. The installation is not proper and complete until the operation of the converted appliance is checked as specified in the manufacturer's instructions supplied with the kit.

## **⚠ CAUTION**

Be sure to electrically ground the appliance.

Keep power cord free of dust.

Do not use the Water Heater for other than hot water supply, shower and bath.

Do not use a broken or modified power cord.  
Do not bind, bend or stretch power cords.  
Do not scratch, modify, or subject them to impact or force.

Do not use condensate, discharged from the condensate drain pipe, for drinking or for consumption by animals.

If the appliance is installed in a location with very high humidity, condensate may form inside the unit and/or cause incomplete combustion, damage to the electrical components, or electric leakage.

Do not turn off the Water Heater while someone is bathing.

Do not cover the Water Heater and the exhaust vent terminal, store trash or debris near it, or in any way block the flow of fresh air to the appliance.

Do not touch the exhaust vent pipe and exhaust vent terminal during or immediately after operation of the Water Heater.

## **NOTICE**

**Do not drink water that has been inside the appliance for an extended period of time. Do not drink the first use of hot water from the appliance in the morning.**

**Clean the filter on the water inlet as frequently as required by the quality of your local water.**

**Keep the area around the appliance clean.** If boxes, weeds, cobwebs, cockroaches etc. are in the vicinity of the appliance, damage or fire can result.

**Do not install the appliance where the exhaust will blow on walls or windows.**

**If the water supply is in excess of 12 gpg (200 mg/L) of hardness, acidic or otherwise impure, treat the water with approved methods in order to ensure full warranty coverage. (See page 26)**

**Problems resulting from scale formation are not covered by the warranty.**

**Check ignition during use and extinction after use.**

**Do not run water through the appliance when appliance is not on.**

When discharging hot water, make sure the appliance is ON. If water is run through the appliance with the appliance OFF, water may condense inside the appliance and cause incomplete combustion or damage to the internal electrical components. For single-handle fixtures, you'd turn the handle to the left.

**This appliance is configured for installations up to 2,000 ft above sea level without changes.**

For installations above 2,000 ft above sea levels, contact Noritz America for Instructions.

**Do not disassemble the Remote Controller.**

**Do not use chlorine-based, acidic, alkaline detergents, organic solvents such as benzene and thinner, or Melamin Sponge to clean the Remote Controller.**

This may cause discoloration, deformation, scratches or cracks.

**Do not splash water on the Remote Controller. Do not expose the Remote Controller to steam.**

It is not water resistant, water can cause damage.

**Do not locate the Remote Controller near stoves or ovens.**

this may cause damage or failure.

**Contact Noritz before using with a solar pre-heater.**

**Preventing damage from freezing (See page 22)**

- Damage can occur from frozen water within the appliance and pipes even in warm environments. Be sure to read below for appropriate measures.
- Repairs for damage caused by freezing are not covered by the warranty.

**Take necessary measures to prevent freezing of water and leakage of gas when leaving the appliance unused for long periods of time. (See page 23)**

**If it is snowing, check the exhaust vent terminal for blockage.**

# Contents

<b>Important Safety Information</b> .....	<b>2</b>
<b>Contents</b> .....	<b>6</b>
<b>General Parts</b> .....	<b>7</b>
Water Heater .....	7
Remote Controller .....	8
<b>Initial Operation</b> .....	<b>10</b>
<b>Clock Adjustment</b> .....	<b>10</b>
<b>Using the Water Heater</b> .....	<b>11</b>
<b>Setting Hot Water Temperature</b> .....	<b>12</b>
<b>Automatic Water Heater ON or OFF</b>	
<b>Operation</b> .....	<b>13</b>
<b>Locking the Remote Controller</b> .....	<b>14</b>
<b>Customizable Settings &lt;Misc settings&gt;</b> ..	<b>15</b>
<b>System Check</b> .....	<b>18</b>
<b>For System [Rcrc]</b>	
Enabling Automatic Recirculation	
Operation .....	19
Manually Starting Recirculation	
Operation .....	19
Setting the Recirculation System	
Operation Timer.....	20
<b>Preventing Damage from Freezing</b> .....	<b>22</b>
<b>Regular Maintenance</b> .....	<b>24</b>
<b>Troubleshooting</b> .....	<b>26</b>
<b>Follow-up Service</b> .....	<b>29</b>
<b>Specifications</b> .....	<b>32</b>
<b>Warranty</b> .....	<b>33</b>

# General Parts

## Water Heater

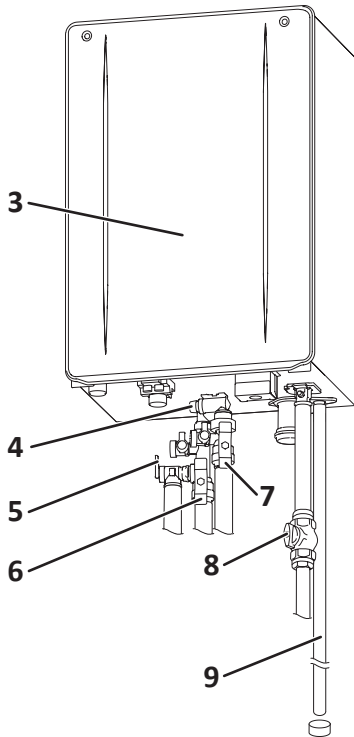

### Indoor Installation

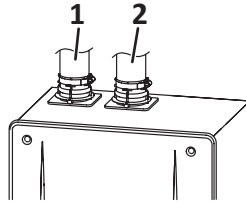

### Outdoor Installation

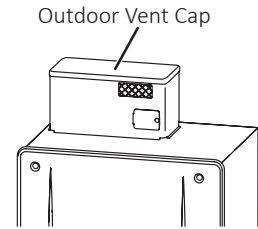

- 1. Intake Pipe

---

- 2. Exhaust Pipe

---

- 3. Front Cover

---

- 4. Water Drain Valve (with Water Filter)  
Inside Water Inlet (See page 25)

---

- 5. Pressure Relief Valve

---

- 6. Hot Water Valve

---

- 7. Water Supply Valve

---

- 8. Gas Supply Valve

---

- 9. Condensate Drain Pipe  
Discharge the condensate.

---

This illustration shows an example of installation. The exact installation configuration may be slightly different.

### The condensing tankless gas Water Heater discharges condensate.

When heat from the exhaust gas is collected within the secondary Heat Exchanger, condensation occurs from moisture in the exhaust gas and the resulting water is discharged from the condensate drain pipe (approximately 2 gallons/h (7.5 L/h) maximum). It is not a water leak. Do not plug or block the drain line as it must always be allowed to freely flow.

Note : The condensate discharged is acidic with a pH level of approximately 2-3. A condensate neutralizer may be required by local code prior to disposal.

### The condensing tankless gas Water Heater tends to emit white steam.

After the exhaust gas passes through the secondary Heat Exchanger, the low temperature and high moisture content tends to produce steam at the vent discharge terminal.

This is a normal occurrence.

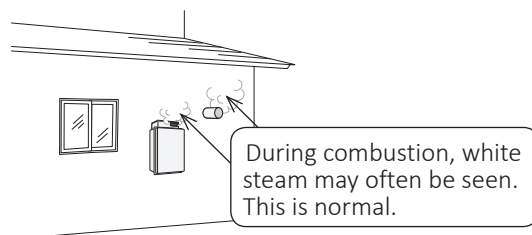

## Remote Controller (RC-9018M)

The Remote Controller will emit a tone when a button is pressed.

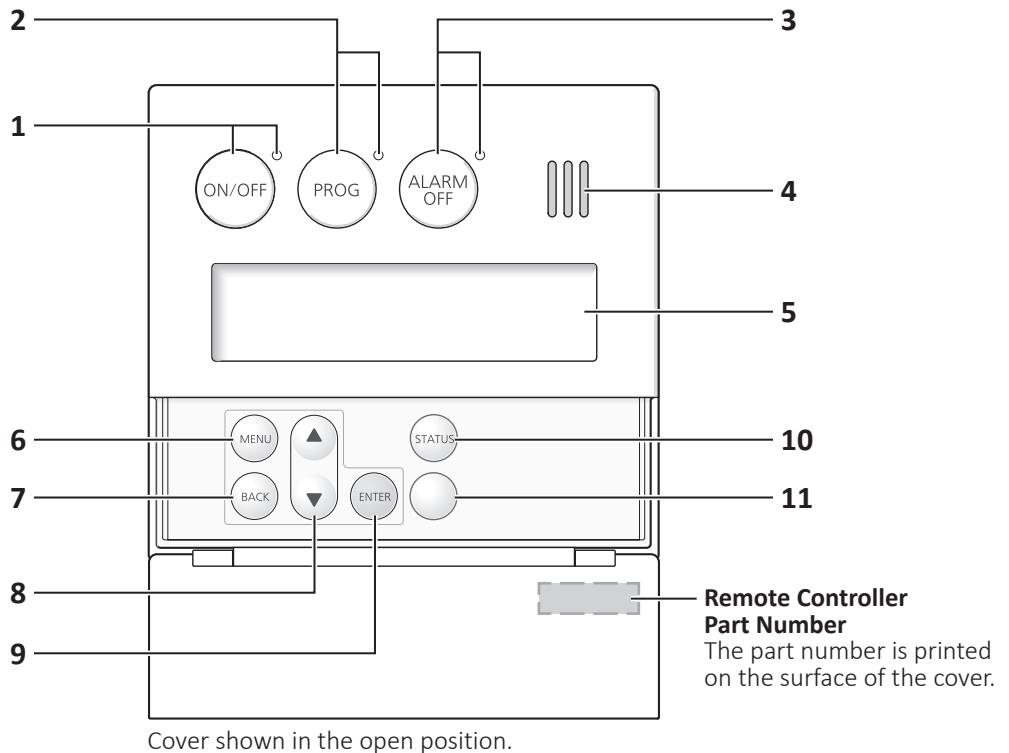

### 1. Power Button / Indicator (Green)

For turning the Water Heater ON/OFF.

### 2. PROG Button / Indicator (Red)

Activate the automatic Water Heater power ON/OFF setting as determined by the user selected schedule. (See page 13)

### 3. ALARM OFF Button / Indicator (Red)

Stop the tone that is emitted when an error occurs. (See page 29)

### 4. Speaker

### 5. Display Screen (See next page)

### 6. MENU Button

Use to change system settings or to return to the home screen.

If you press the MENU button and press the ▲/▼ buttons, "Sys monitor" is sometimes displayed, however, do not use this mode as it meant for installation or service technician only.

### 7. BACK Button

Return to the previous screen while making system settings or checking status.

### 8. ▲ / ▼ Buttons

For setting the hot water temperature (See page 12), the flow meter alarm, and other settings.

### 9. ENTER Button

Confirm changes made by the user.

### 10. STATUS Button

Check the status of the system or the number of installed the Water Heater. (See page 18)

### 11. Lock Button

Lock Remote Controller operation. (See page 14)



## Display Screen

- The display screen shown below is for illustration purposes only. The actual display will vary depending on how the Water Heater is being used.
- After a button is pressed, the display will gradually become darker to prevent unnecessary power consumption by the Remote Controller.

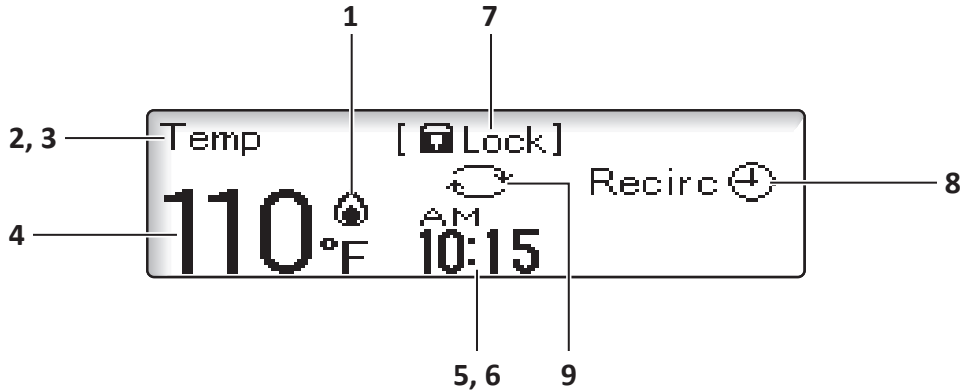

### 1. Flame Indicator

The flame indicator is displayed during combustion when using hot water or recirculation functions.

### 2. Display for Temperature Setting

During normal operation, "Temp" is displayed.

### 3. Display for High Temperature "Hi temp"

Displays when the set temperature is 125°F / 55°C or higher. (See page 12)

### 4. Temperature Setting (e.g. 110°F)

### 5. Clock Display (e.g. 10:15 am)

Normally the clock display is not shown when the Power button is OFF.

\* This setting can be changed so that the clock is displayed even when the Power button is turned OFF. (See page 15)

### 6. Error Code

A number will flash if a failure occurs.

### 7. Locked Display

The lock symbol is displayed when the Remote Controller is locked. (See page 14)

### 8. Recirculation Timer

The clock symbol is displayed when the recirculation timer is activated. (See page 20)

### 9. Display for Recirculation Operation

- For systems that use recirculation operation, the symbol is displayed when the Power button is turned ON.
- It is displayed during the recirculation operation. (See page 11)

**NOTE** As shipped from the factory, the Remote Controller is set to display in °F and gallons. To adjust the display to °C and liters, refer to the Installation Manual.

## What is the home screen?

The home screen is displayed when the Power button is ON. Normally, the hot water temperature and the clock, etc. are displayed.



(Home Screen Example)

# Initial Operation

Before the first use, do the following:

1. Open the water supply valve.

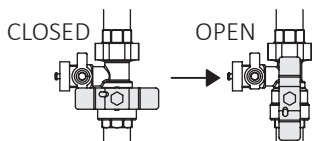

2. Open a hot water fixture/faucet to confirm that water is available, and then close the fixture/faucet again.

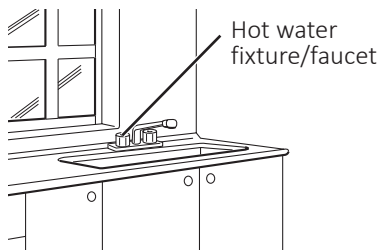

3. Open the gas supply valve.

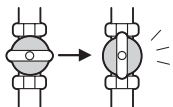

4. Turn on the power.

## ⚠ WARNING

Do not touch the power cord with wet hands.

# Clock Adjustment

## Operation

1. Press the **MENU** button inside the cover.

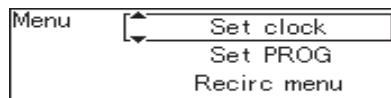

- This adjustment can be made whether the **Power** button is ON/OFF.

2. Press the **ENTER** button.



3. Use the **▲/▼** buttons to reset the clock.

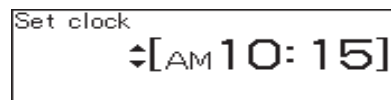

(e.g. 10:15 am)

- The time changes in 1 minute increments with each press of the button, and then in 10 minutes increments if the button is pressed and held.

4. Press the the **ENTER** button to complete the clock setting.

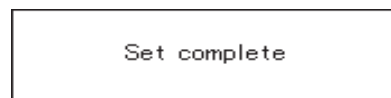

The screen returns to the previous screen.

- If the display is left untouched for approximately 20 seconds without pressing the **ENTER** button, the setting will be completed. When the **Power** button is turned ON, the home screen will be restored.

- NOTE**
- In the event of a power outage or after disconnecting power to the Water Heater, when power is restored, the clock on the display screen will show “- : -” and the clock will need to be reset.
  - By default, when the **Power** button is turned OFF, the clock display disappears, but it is possible to display the clock when the **Power** button is turned OFF by changing a setting. (See page 15)

# Using the Water Heater

If "System [ Tank ]" is displayed, hot water will be discharged at the temperature of the storage tank. (See page 18)

## Operation

1. The **Power** button is ON.

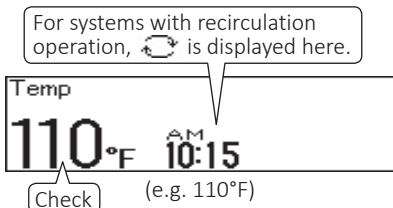



- The Power indicator is displayed.
- The previously set hot water supply temperature is shown.
- The setting temperature displayed may vary from the actual temperature at the fixture depending on conditions such as season or length of piping.

[For systems with recirculation operation]

- If you set the **Power** button to ON, recirculation operation is automatically started. (If "Synchro ON/OFF" was set to ON. (See page 19))

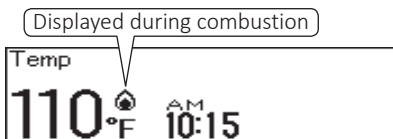
2. Turn on hot water.



- Turn off hot water, the symbol  disappears.
- During recirculation, the symbol  may be continuously displayed.

## DANGER

- **To prevent scalding :**  
**Hot Water Heater temperatures over 125°F (52°C) can cause severe burns instantly or death from scalding.**
- Children, disabled and elderly are at the highest risk of being scalded. Feel water temperature before bathing or showering. Temperature limiting valves are available, consult with installer.
- When setting the Water Heater to 125°F (55°C in °C mode) or higher, "Hi temp" will blink for 10 seconds and emit a tone as a high temperature warning.
- Take caution when using the Water Heater again after setting to 125°F (52°C) or higher. Always check the set temperature before use.
- Do not allow anyone to change the water temperature while hot water is running.

# Setting Hot Water Temperature

If “System [ Tank ]” is displayed, hot water will be discharged at the temperature of the storage tank. (See page 18)

## Operation

1. The **Power** button is ON.

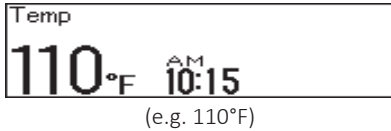

- The Power indicator is displayed.
- The previously set hot water supply temperature is shown.

2. Set the temperature using the ▲/▼ buttons inside the cover.

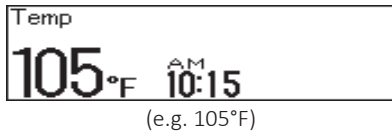

- NOTE**
- Hot water temperatures shown are approximate and may differ from the actual temperature at the fixture depending on external factors such as the season and length of piping in the system.
  - When low temperatures are set (for washing dishes, etc.), if the incoming water temperature is already quite high, it may be difficult to ensure the outgoing water temperature is as per the setting.
  - Check the temperature displayed before using any hot water. Be especially careful using hot water after the set temperature has been changed.
  - When the hot water temperature is adjusted using thermostatic water mixing valves, set the temperature on the Remote Controller approximately 20°F (10°C) higher than the required temperature to ensure the appropriate fixture temperature.

## Temperature Setting Options

The temperature settings below are examples. The temperature setting necessary depends on the usage, the length of piping and the season.

**[When using °F mode]** (Default setting is 110°F)

100°F	Washing dishes, etc.
105°F	
110°F	Shower, hot water supply, etc.
115°F	
120°F	
125°F	
130°F	
135°F	High temperature*
140°F	
145°F	(The maximum output temperature can be set using the remote controller. (See page 15))
150°F	
160°F	
170°F	
185°F	

**[When using °C mode]** (Default setting is 40°C (104°F))

37°C (99°F)	Washing dishes, etc.
38°C (100°F)	
39°C (102°F)	Shower, hot water supply, etc.
40°C (104°F)	
41°C (106°F)	
42°C (108°F)	
43°C (109°F)	
44°C (111°F)	
45°C (113°F)	
46°C (115°F)	
47°C (117°F)	High temperature*
48°C (118°F)	
50°C (122°F)	
55°C (131°F)	
60°C (140°F)	
65°C (149°F)	
70°C (158°F)	
75°C (167°F)	
80°C (176°F)	(The maximum output temperature can be set using the remote controller. (See page 15))
85°C (185°F)	

\* Display when high temp is set

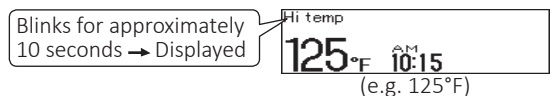

- NOTE**
- If the set temperature requires frequent adjustment, locate the Remote Controller in an easily accessible location.
  - Consult local codes for minimum operating temperatures.
  - Noritz recommends that water temperature is set as low as possible to prevent scale build-up in the heat exchanger.

# Automatic Water Heater ON or OFF Operation

- If you set the time to turn ON or OFF the **Power** button, the **Power** button is automatically turned ON or OFF at the set time every day by just turning the **PROG** button ON.
- It is also possible to set only ON or OFF operation.
- For recirculation systems, circulation is started or stopped according to the **Power** button condition, ON or OFF.

## Operation

### Set the time to turn ON or OFF the Power button automatically

This example describes setting the “ON time” and “OFF time” to 10:00 am and 8:00 pm, respectively.

1. Check that the current time is properly set.  
(Setting the time : See page 10)
2. Check the **PROG** button is set to OFF.
3. Press the **MENU** button inside the cover, Select “Set PROG” using the ▲/▼ buttons.



- This adjustment can be made whether the **Power** button is ON/OFF.

4. Press the **ENTER** button.

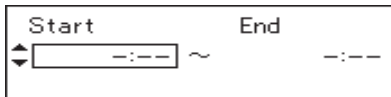

- The previously set “Start time” and “End time” are displayed.

5. Set the ON time to “AM 10:00” using the ▲/▼ buttons.

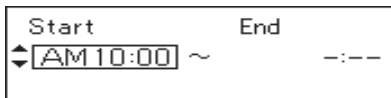

- The time changes in 10 minutes increments with each press of the button, and then in 1 hour increments if the button is pressed and held.
- If you do not want to set the “Start time”, select “- :--” (located between AM 11:50 and PM 0:00 settings).

6. Press the **ENTER** button to complete the setting.

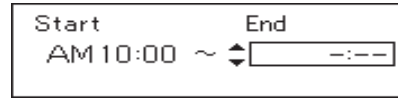

7. Set the OFF time to “PM 8:00” using the ▲/▼ buttons.

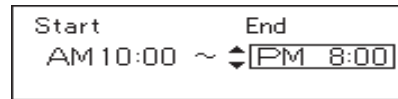

- Follow the same procedure from step 5.

8. Press the **ENTER** button to complete the setting.

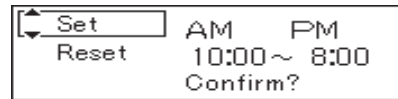

9. Check “Set” is selected, and then press the **ENTER** button to confirm all settings.



- If the display is left untouched for approximately 20 seconds without pressing the **ENTER** button, the setting will be completed. When the **Power** button is turned ON, the home screen will be restored.
- If you want to change “ON/OFF time”, select “Reset” and then press the **ENTER** button, return to step 5.

### Activate Automatic Operation

The **PROG** button is ON.

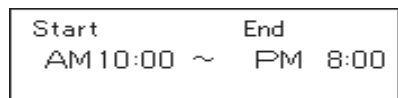

(Display Example)

- You can activate automatic operation regardless if the **Power** button is ON or OFF.
- The PROG indicator is displayed when activated.
- “Start time” and “End time” will be displayed upon activation.
- If both the “Start time” and “End time” are set to “- :--”, the alarm sounds and “Set PROG” will display.

## Deactivate Automatic Operation

The **PROG** button is OFF.

- The PROG indicator disappears.

- NOTE**
- If the **PROG** button is not set to OFF, the Water Heater will automatically turn ON or OFF at the set times.
  - If there is a power failure or power is disconnected to the Water Heater, automatic operation will be deactivated.

## Tips for operation

Following this procedure allows for automated control of Water Heater operation without user interaction.  
(The setting time shown on the display of the Remote Controller is for example purposes only.)

### e.g. Both ON and OFF functions are automated.

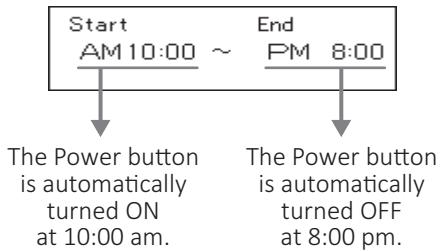

### e.g. Only ON function is automated.

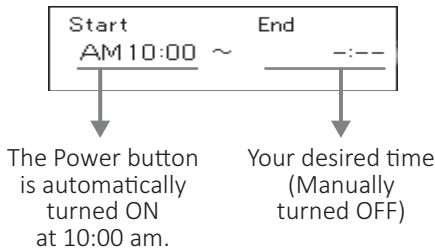

### e.g. Only OFF function is automated.

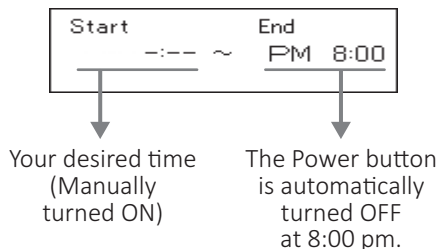

# Locking the Remote Controller

By locking the Remote Controller, the settings cannot be changed if a button is pressed by mistake.

## Operation

- Press and hold **Lock** button for approximately 2 seconds to lock the Remote Controller.



- This adjustment can be made whether the **Power** button is ON/OFF.
- The operations of **PROG** button, **MENU** button, and **▲/▼** buttons are locked.
- Approximately 3 seconds after locking the Remote Controller, the display will return to the previous screen.

- If you press **PROG** button, **MENU** button, and **▲/▼** buttons while the Remote Controller is locked, the "Locked" screen will appear.



- Approximately 3 seconds after the "locked" screen appears, the display will return to the previous screen.

## Unlock the Remote Controller

Press and hold **Lock** button for approximately 2 seconds to unlock the Remote Controller.

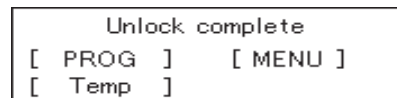

- Approximately 3 seconds after unlocking the Remote Controller, the display will return to the previous screen.

# Customizable Settings

## Limiting the Maximum Output Temperature

The maximum output temperature can be limited to prevent discharging hot water at too high of a temperature.

### Operation

1. The **Power** button is OFF.
2. Press the **MENU** button inside the cover, select “Misc settings” using the ▲ / ▼ buttons.
3. Press the **ENTER** button.
  - The “Misc settings” screen appears.
4. Select “Max set temp” using the ▲ / ▼ buttons, and then press the **ENTER** button.
5. Change the setting using the ▲ / ▼ buttons. (Setting completed.)

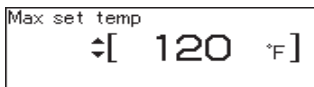

(e.g. 120°F)

[For Fahrenheit (°F)]  
100- 150°F (In 5°F intervals),  
160°F, 170°F, 185°F  
[For Celsius (°C)]  
37- 48°C (In 1°C intervals),  
50- 85°C (In 5°C intervals)

(Default setting = 120°F/50°C)

- To change other settings, select the option and press the **ENTER** button.
- To return to the home screen, press the **MENU** button or let it sit for approximately 20 seconds.

## Display Screen Power Saving Mode [powersave dsply]

To conserve power consumption of the display, the screen can be turned off completely or set to only display the clock when the **Power** button is turned OFF.

### Operation

1. Press the **MENU** button inside the cover, select “Misc settings” using the ▲ / ▼ buttons.
2. Press the **ENTER** button.
  - The “Misc settings” screen appears.
3. Select “Powersave dsply” using the ▲ / ▼ buttons, and then press the **ENTER** button.
4. Change the setting using the ▲ / ▼ buttons. (Setting completed.)



(e.g. No-1)

Yes : The display will turn off. The clock will not be displayed when the **Power** button is turned OFF.  
No-1: The display will not turn off. The clock will not be displayed when the **Power** button is turned OFF.  
No-2: The display will not turn off. The clock is displayed when the **Power** button is turned OFF.

(Default setting = No-1)

- To change other settings, select the option and press the **ENTER** button.
- To return to the home screen, press the **MENU** button or let it sit for approximately 20 seconds.

## Adjusting the brightness of the display screen when the Remote Controller is turned on

The display screen can be brightened, darkened, or the backlight can be turned off completely.

### Operation

1. Press the **MENU** button inside the cover, Select “Misc settings” using the ▲ / ▼ buttons.
2. Press the **ENTER** button.
  - The “Misc settings” screen appears.
3. Select “Brightness” using the ▲ / ▼ buttons, and then press the **ENTER** button.
4. Change the setting using the ▲ / ▼ buttons. (Setting completed.)

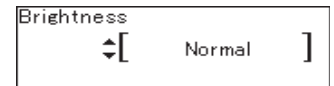

(e.g. Normal)

Dark / Dim / Normal / Bright

(Default setting = Normal)

- To change other settings, select the option and press the **ENTER** button.
- To return to the home screen, press the **MENU** button or let it sit for approximately 20 seconds.

## Muting the Remote Controller

The Remote Controller can be muted so that it does not emit a tone when a button is pressed.

### Operation

1. Press the **MENU** button inside the cover, select “Misc settings” using the ▲/▼ buttons.
2. Press the **ENTER** button.
  - The “Misc settings” screen appears.
3. Select “Touch sound” using the ▲/▼ buttons, and then press the **ENTER** button.
4. Change the setting using the ▲/▼ buttons. (Setting completed.)

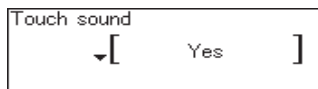

(e.g. Yes)

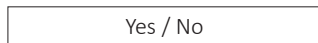

(Default setting = Yes)

- To change other settings, select the option and press the **ENTER** button.
- To return to the home screen, press the **MENU** button or let it sit for approximately 20 seconds.

## (For Multi-System Only) Error Tone Settings

The Remote Controller can be muted so that it does not emit a tone when an error occurs.

### Operation

1. Press the **MENU** button inside the cover, select “Misc settings” using the ▲/▼ buttons.
2. Press the **ENTER** button.
  - The “Misc settings” screen appears.
3. Select “Error alarm” using the ▲/▼ buttons, and then press the **ENTER** button.
4. Change the setting using the ▲/▼ buttons. (Setting completed.)

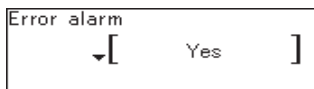

(e.g. Yes)

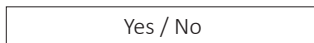

(Default setting = Yes)

- To change other settings, select the option and press the **ENTER** button.
- To return to the home screen, press the **MENU** button or let it sit for approximately 20 seconds.

## Draining the Water Heater

(Refer to page 23 for details.)

### Operation

1. The **Power** button is OFF.
2. Press the **MENU** button inside the cover, select “Misc settings” using the ▲/▼ buttons.
3. Press the **ENTER** button.
  - The “Misc settings” screen appears.
4. Select “Drain water” using the ▲/▼ buttons, and then press the **ENTER** button.
5. Select “Yes” using the ▲/▼ buttons.

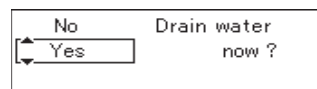

6. Press the **ENTER** button.

Follow the drain procedures in the manual

- Drain the Water Heater following the procedures described on page 23.

## Stop draining water from the Water Heater

If you press the **ENTER** button again when “Drain water” and “Operating” are alternately displayed following step 6, the drain function will stop.



## (Single Water Heater only) Flow Meter Alarm

The flow meter alarm is being used to indicate when a tub is full.

### Operation

1. The **Power** button is ON.
  - Check the current setting temperature.
2. Press the **MENU** button inside the cover, select “Flow meter” using the ▲/▼ buttons.
3. Press the **ENTER** button.
  - The “Flow meter” screen appears.
4. Change the volume using the ▲/▼ buttons, and then press the **ENTER** button.

[For gallon] 10- 60 gal (In 5 gal intervals), 60- 100 gal (In 10 gal intervals), Alarm off [For liter] 40- 260 L (In 20 L intervals), 260- 380 L (In 40 L intervals), Alarm off
--

(Default setting = Alarm off)

- To return to the home screen, press the **MENU** button or let it sit for approximately 20 seconds.
5. Turn on hot water.
    - When the tub fills with the preset volume of water, an alarm will sound alerting you to shut off the water.
  6. Turn off the hot water when the alarm sounds to prevent overfilling.

- NOTE**
- The hot water filling temperature is same as the setting temperature.
  - Although the temperature can be set to 125°F/50°C or higher, do not set the temperature to 125°F/50°C or higher as it can cause severe burns instantly or death from scalding.

# System Check

- Depending on the configuration of your system, not all functions may be used.
- If you press the **STATUS** button, you can check the status of the system.

```

[System [ Rrcr ] Active [ 06 ]
Units   [ 06 ] Pump1 [ OFF ]
Online  [ 06 ] Pump2 [ ON ]
    
```

(Display Example [System [ Rrcr ]])

- The pictures below (the number of Water Heaters, fixtures, and pumps) will vary depending on the configuration of the hot water system.

## Display "System [ Std ]" on the Remote Controller

The Water Heater only operation. (Functions other than those shown on pages 19 to 21 can be used.)

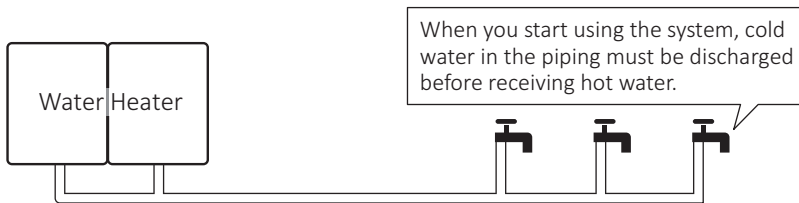

## Display "System [ Rrcr ]" on the Remote Controller (For Multi-System only)

- The Water Heater and recirculation operation. (All functions can be used.)
- During recirculation operation, hot water is always circulated in the piping to provide instant hot water when a fixture is opened. (When setting the recirculation system operation timer, the recirculation system operates at the set times.)
- If you set the **Power** button to ON,  is displayed. (If "Synchro ON/OFF" is set to ON. (See page 19))

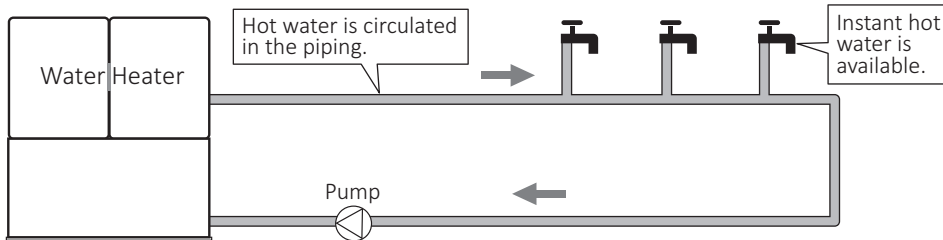

## Display "System [ Tank ]" on the Remote Controller (For Multi-System only)

- The Water Heater combined with a storage tank operation. (Functions other than those shown on pages 19 to 21 can be used.)
- If a recirculation system is also installed, hot water is always circulated in the piping to provide instant hot water when a fixture is opened.
- If you set the **Power** button to ON,  is displayed.

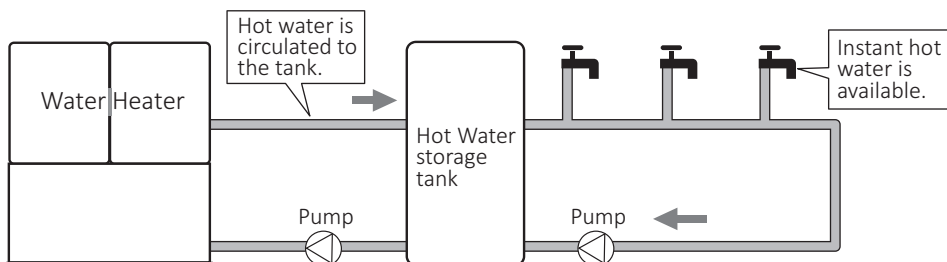

For "System [ Rrcr ]"

## Enabling Automatic Recirculation Operation

- To check system status, see page 18.
- When "Synchro ON/OFF" is set to Yes, recirculation can be activated automatically.
- To change "Synchro ON/OFF" from Yes to No, follow the same procedure as described below.

### Operation

1. Press the **MENU** button inside the cover, select "Recirc menu" using the ▲/▼ buttons.



- This adjustment can be made whether the **Power** button is ON/OFF.

2. Press the **ENTER** button.

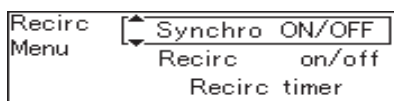

3. Select "Synchro ON/OFF" using the ▲/▼ buttons, and then press the **ENTER** button.

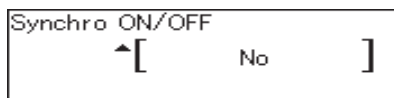

4. Select "Yes" using the ▲ button.

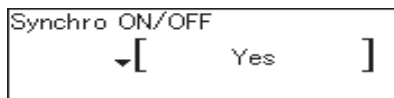

5. Press the **ENTER** button.

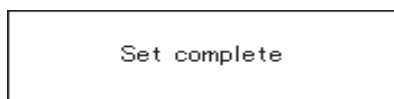

The screen returns to the previous screen.

- If the display is left untouched for approximately 20 seconds without pressing the **ENTER** button, the setting will be completed. When the **Power** button is turned ON, the home screen will be restored.

For "System [ Rrcr ]"

## Manually Starting Recirculation Operation

Recirculation operation can be manually stopped or started using this procedure.

### Operation

1. The **Power** button is ON.

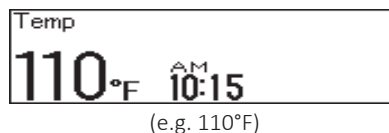

- The Power indicator is displayed.
- The previously set hot water supply temperature is shown.

2. Press the **MENU** button inside the cover, select "Recirc menu" using the ▲/▼ buttons.

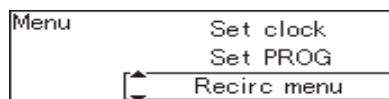

3. Press the **ENTER** button.

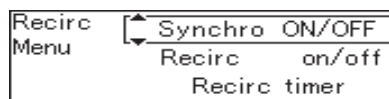

4. Select "Recirc on/off" using the ▲/▼ buttons.

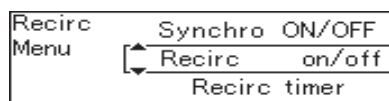

5. Press the **ENTER** button.

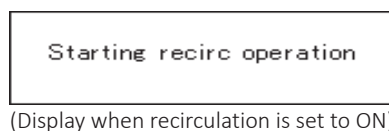

The screen returns to the previous screen.

- Display "Stopping recirc operation" when the recirculation is set to OFF.
- If the display is left untouched for approximately 20 seconds without pressing the **ENTER** button, the setting will be completed. The home screen will be restored.

For "System [ Rrcrc ]"

# Setting the Recirculation System Operation Timer

- With the recirculation operation timer set, hot water will be automatically circulated in the hot water pipes.  
Even with this function activated, it may take several minutes for hot water to be completely circulated through the plumbing system. Set the timer to activate the recirculation system prior to the first use of hot water to ensure hot water is instantly available.
- Multiple recirculation time periods can be set.
- Until the timer is deactivated (See page 21), the recirculation system will operate daily at the set times.
- When the recirculation system is turned OFF by the timer, the Water Heater will still remain ON and can be used normally.

## Operation

This example describes setting the recirculation system to operate between 5:00 am- 8:00 am.

1. Check that the current time is properly set. (Setting the time : See page 10)
2. Press the **MENU** button inside the cover, Select "Recirc menu" using the ▲/▼ buttons.

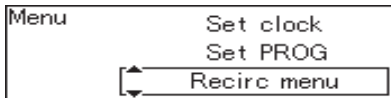

- This adjustment can be made whether the **Power** button is ON/OFF.

3. Press the **ENTER** button.

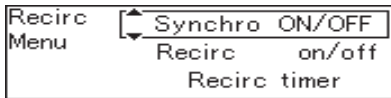

4. Select "Recirc timer" using the ▲/▼ buttons.



(Display Example)

- The previous setting is displayed.

5. Press the **ENTER** button.

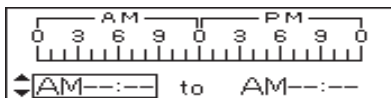

6. Select "AM 5:00" using the ▲/▼ buttons.

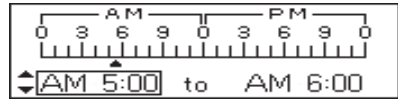

- Every time when you press the button, the time changes by one hour.
- [To add additional time periods to the current setting, or to cancel the previous setting]
  - 1) Press the **ENTER** button without setting "Start" time.
  - 2) Press the **ENTER** button without setting "End" time.
  - 3) Follow the procedures "Adding Additional Time Periods" or "Resetting All Time Periods". (See page 21)

7. Press the **ENTER** button to complete the "Start" time setting.

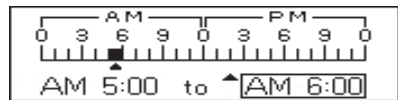

8. Select "AM 8:00" using the ▲/▼ buttons.

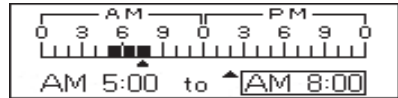

- Every time when you press the button, the time changes by one hour.

9. Press the **ENTER** button to complete the "End" time setting.

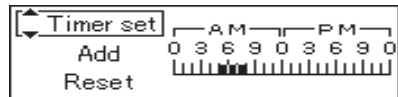

- Press the **ENTER** button to complete the time setting.

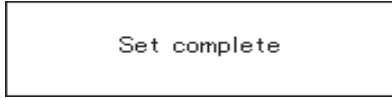

“Recirc timer” and “Recirc timer on” are alternately displayed on the menu (approximately 10 seconds)



(Example of home screen when the **Power** button is turned ON)

- The timer will not activate without pressing the **ENTER** button.
- If the time is not set, the time setting screen is displayed. (See page 10)
- Until the timer is deactivated, the recirculation system will operate daily at the set “Start” and “End” times.

### Add Additional Time Periods

- After step 9 on page 20, select “Add” using the ▲/▼ buttons.

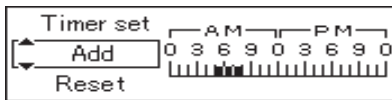

- You can set multiple operation time periods.

- Press the **ENTER** button.

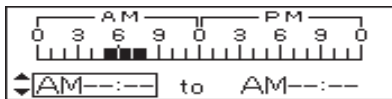

- Select the time period following the procedures in steps 6 to 9 on page 20.

### Reset All Time Periods

- After step 9 on page 20, select “Reset” using the ▲/▼ buttons.

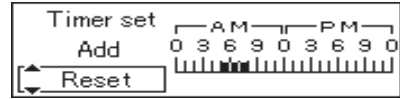

- Press the **ENTER** button.

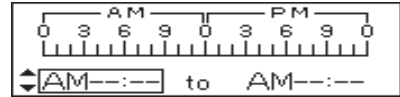

(All settings are cleared.)

- Adjust the time period following the procedures in steps 6 to 9 on page 20.

### Cancel the Recirculation System Operation Timer

- Carry out steps 1 to 5 on page 20.
- Select “Cancelled” using the ▲/▼ buttons.



- Press the **ENTER** button.

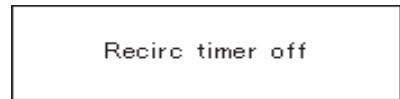

The screen returns to the “Recirc Menu”.

- If the **Power** button is ON, the screen returns to the home screen in approximately 10 seconds.
- If the timer is deactivated during a recirculation time period, recirculation will continue until it is stopped using the procedure shown on page 19.

# Preventing Damage from Freezing

## NOTICE

- Damage can occur from frozen water within the appliance and pipes even in warm environments. Be sure to read below for appropriate measures.
- Repairs for damage caused by freezing are not covered by the warranty.

## Freezing is prevented within the device automatically by the freeze prevention heater.

Freezing cannot be prevented when the power plug is unplugged. Do not remove the power plug from the wall outlet.

Freezing will be prevented regardless of whether the **Power** button is ON or OFF.

- In normal operation, freezing is prevented within the Water Heater automatically unless the outside temperature without wind is below -30°F (-35°C) when supplying combustion air from the outdoor (Direct Vent) or -4°F (-20°C) when the Water Heater is installed outdoors.
- For indoor installation, when supplying combustion air from the indoors, the room temperature must be greater than 32°F (0°C) to prevent freezing and the room inside must not have negative pressure.
- The freeze prevention heaters will not prevent the plumbing external to the Water Heater from freezing. Protect this plumbing with insulation, heat tape or electric heaters, solenoids, or pipe covers. If there remains a freezing risk, contact the nearest Noritz agent.

## Take the measures below for extremely cold temperatures\*.

\* Outside temperature including wind chill factor less than -30°F (-35°C) when supplying combustion air from the outdoor (Direct Vent) or -4°F (-20°C) when the Water Heater is installed outdoors.

This method can protect not only the Water Heater, but also the water supply, water piping and mixing valves.

1. Turn off the **Power** button.
2. Close the gas supply valve.
3. Open a hot water fixture/faucet, and keep a small stream of hot water running. (0.1 gallon (400 mL)/minute or about 0.2 in. (4 mm) thick.)
  - If there is a mixing valve, set it to the highest level.
  - When linking multiple Water Heaters, discharge water equivalent to (0.1 gallon (400 mL)/minute per Water Heater.)
4. The flow may become unstable from time to time. Check the flow 30 minutes later.
  - In general, it is not advisable to run water through the Water Heater when it is OFF (See page 5), but in this case freeze prevention is more important.

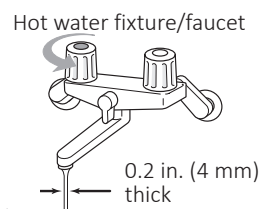

- NOTE**
- Remember to set mixing valves and fixtures to their original levels before using the Water Heater again to prevent scalding.
  - If there is still a risk that the Water Heater will freeze, drain the Water Heater as shown on the next page.

## If water will not flow because it is frozen

1. Close the gas and water valves.
2. Turn off the **Power** button.
3. Open the water supply valve from time to time to check whether water is running.
4. When the water is flowing again, check for water leaks from the Water Heater and piping before using.

**NOTE** If the Water Heater or the piping is frozen, do not use the Water Heater or it may get damaged.

## If the Water Heater will not be used for a long period of time, drain the water.

### ⚠ WARNING

- To prevent burns or scalding, turn off the **Power** button and wait until the appliance cools before draining the water
  - Do not touch the power cord with wet hands.
- To prevent damage from freezing, the Water Heater must be plugged into power at all times. If power is unplugged, drain the water completely from the Water Heater. Then use an air compressor to remove all water from inside the water piping of the Water Heater.
  - It is recommended that Isolation Valves are installed on the Water Heater, otherwise the water connections will need to be removed to drain the Water Heater completely.
  - Freeze damage due to not draining properly will not be covered under warranty.
  - Drain water into a bucket to prevent water damage.

### Drainage Using the Remote Controller

1. The **Power** button is OFF.
2. Press the **MENU** button inside the cover, select "Misc settings" using the ▲/▼ buttons, and then press the **ENTER** button. (The "Misc settings" screen appears.)
3. Select "Drain water" using the ▲/▼ buttons, and then press the **ENTER** button.
4. Select "YES" using the ▲/▼ buttons, and then press the **ENTER** button. (The "Follow the drain procedures in the manual" screen appears.)
5. Close the water supply valve.

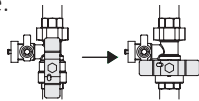

6. Fully open all hot water fixtures/faucets.

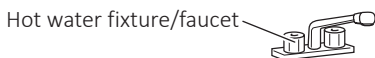

7. Open all drain plugs and drain the water out of the Water Heater.
8. When the water is completely drained, reattach all drain plugs and close the hot water fixtures/faucets.
9. Close the gas valve and disconnect the electrical power supplied to the Water Heater.

**Do not touch with wet hands.**

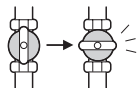

### Manual Draining

1. Close the gas valve.

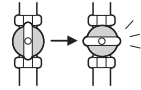

2. Turn the **Power** button ON.
3. Turn and leave open the hot water fixtures/faucets for more than 2 minutes and close.
  - \* If multiple Water Heaters are being used, drain 2 minutes for each Water Heater.
  - \* An 11 Error Code may appear on the Remote Controller. This is not a malfunction of the Water Heater. Do not turn **Power** button OFF.

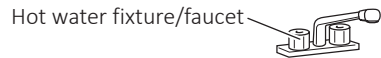

4. Close the water supply valve and disconnect the electrical power supplied to the Water Heater.

**Do not touch with wet hands.**

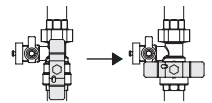

5. Fully open all hot water fixtures/faucets.

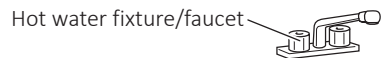

6. Open all drain plugs and drain the water out of the Water Heater.

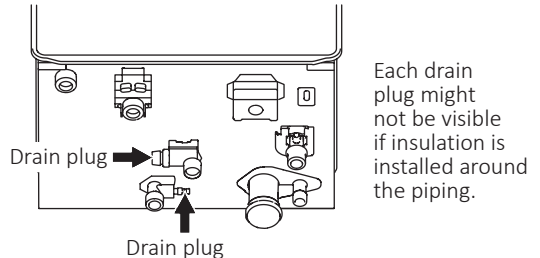

7. When the water is completely drained, reattach all drain plugs and close the hot water fixtures/faucets.

## Turning the Water Heater Back On

### **⚠ DANGER**

After the Water Heater has been out of use for a long time, make sure that you fill the condensate trap with water.

This is to prevent dangerous exhaust gases from entering the building.

Failure to fill the condensate trap could result in severe personal injury or death.

(By performing step 4 as described below, the condensate trap will automatically fill itself with water.)

### **⚠ WARNING**

Do not touch the power cord with wet hands.

1. Check that all drain plugs are inserted.
2. Check that all hot water fixtures/faucets are closed.
3. Open the water supply valve.
4. Open a hot water fixtures/faucets to confirm that water is available, and then close the hot water fixtures/faucets again.
5. Open the gas supply valve.
6. Connect the electrical power.
7. **Do not touch with wet hands.** Make sure that the area around the appliance is well ventilated; open a window or a door if necessary. Then, operate the Water Heater and verify that condensate is coming out of the condensate drain pipe. (During normal use of the Water Heater, condensate will begin to discharge from the condensate drain pipe within 15 minutes of use. However, depending on the season and/or installation site conditions, it may take longer.)

**NOTE** If water does not appear at the end of the drain line, a qualified service technician must clean the condensate line.

## Regular Maintenance

### Periodic Inspection

Periodic check and maintenance should be performed once a year by a qualified service technician to assure that all the equipment is operating safely and efficiently.

We recommend to make necessary arrangements with a service contractor.

### **⚠ WARNING**

To prevent burns or scalding, turn off the **Power** button and wait until the appliance cools before performing maintenance.

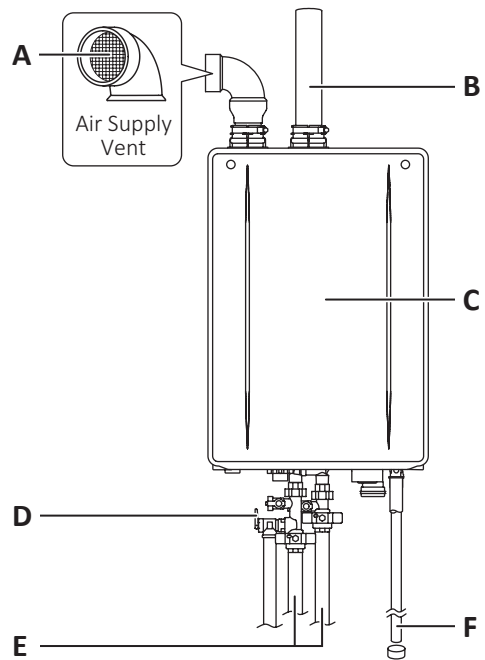

#### **Check : A**

[When supplying combustion air from the indoors]  
For smear or blockage with dust, oil, etc. at the air supply vent.

If blocked, remove the build-up with a vacuum cleaner or damp towel.

**NOTE** Do not permanently remove the Inlet Screen.

#### **Check : B**

For dust and soot in the exhaust vent or the exhaust vent terminal.



---

**Check : C**

- For abnormal sounds during operation.
  - For abnormalities in external appearance, discoloration or flaws.
- 

**Check : D**

For proper operation of pressure relief valve.

---

**Check : E**

For water leaks from the Water Heater and piping.

---

**Check : F**

For blockage at the condensate drain pipe discharge.

---

**Check**

For laundry, newspaper, timber, oil, spray cans and other combustible materials near the Water Heater or the exhaust vent terminal.

---

## Periodic Maintenance

### Water Heater

Wipe the outside surface with a wet cloth, then dry the surface. Use a neutral detergent to clean any stains.

If an external condensate neutralizer is installed, periodic replacement of the neutralizing agent will be required. Refer to the instructions supplied with the neutralizer for suggested replacement intervals.

### Remote Controller

Wipe the surface with a wet cloth.

- NOTE**
- Do not use chlorine-based, acidic, alkaline detergents, organic solvents such as benzine and thinner, or Melamin Sponge to clean the Remote Controller.; discoloration, deformation, scratches or cracks may occur.
  - The Remote Controller is not water resistant. Keep it dry.

### Water Drain Valve (with Water Filter)

If the water drain valve (with water filter) is covered with debris, the hot water may not run smoothly, or the Water Heater may put out cold water. Check and clean the filter as explained below.

#### **WARNING**

To prevent burns or scalding, turn off the **Power** button and wait until the appliance cools before draining the water.

1. Close the hot water valve and the water supply valve.

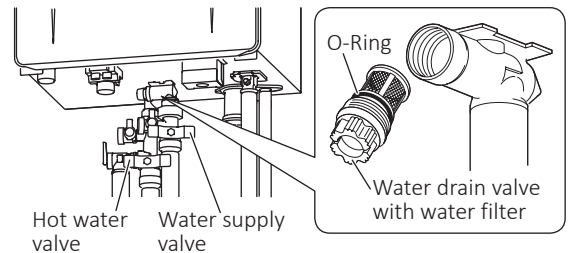

2. With a bucket ready, remove the water drain valve.

**NOTE** Approximately 0.80 gallon (3.0 L) of water will drain out.

3. Clean the water filter with a brush under running water.
4. Reattach the water drain valve (with water filter).

**NOTE** Take care not to lose the O-Ring.

5. Open the hot water valve and the water supply valve. Check that water does not leak from the water drain valve.

## Water Quality and Maintenance

- For people who live in a hard water area, periodic flushing is necessary. If the Heat Exchanger is not flushed, the Scale Build-up may cause damage to the Heat Exchanger.

To prevent damage to the Heat Exchanger, the Heat Exchanger regularly needs to be flushed.

- This Water Heater is equipped with an automatic service reminder to announce for flushing the Heat Exchanger.

The factory default of this service reminder is disable.

If desired, the customer or installer needs to enable the service reminder (connect the red connector marked "SERVICE REMINDER").

Refer to the "Water Treatment: About the Service Reminder" in the Installation Manual.

- If the service reminder is selected to ON, the code "C1#" (#=1,2,3,4 ... 9) will displayed on the Remote Controller after the set time period has been reached. When the code is displayed, the Heat Exchanger needs to be flushed to prevent damage from Scale Build-up. Refer to the "Procedure for flushing the Heat Exchanger" in the Installation Manual or contact Noritz America for more information. (<http://support.noritz.com/> or 1-866-766-7489)
- Damage to the Water Heater as a result of below is not covered by the Noritz America Limited Warranty. To ensure full warranty coverage, treat or condition water that exceeds the target levels provided in this table.
  - Water in excess of 12 gpg (200 mg/L) of hardness
  - Poor water quality (see the following table)
  - The Water Heater has displayed a "C1#" (Service Reminder) indicating Scale Build-up, but the heat exchanger has not been flushed.

Contaminant	Maximum Allowable Level
Total Hardness*	200 mg/L (12 gpg) or less
Aluminum	0.05 to 0.2 mg/L or less
Chloride	250 mg/L or less
Copper	1.0 mg/L or less
Iron	0.3 mg/L or less
Manganese	0.05 mg/L or less
pH	6.5-8.5
Total Dissolved Solids	500 mg/L or less
Zinc	5 mg/L or less
Sulfate	250 mg/L or less
Residual chlorine*	4 mg/L or less

Source: EPA National Secondary Drinking Water Regulations (40 CFR Part 143.3)

\* Maximum limit suggested by Noritz.

# Troubleshooting

## Initial Operation

### The Water Heater does not attempt to ignite when water is running.

- Check for reversed plumbing or crossed pipes.
- Check the water filter. (See page 25)

### The Water Heater attempts to ignite but fails.

- Reset the Water Heater and try again. There may be air in the gas line.
- Have a professional check the gas supply pressure.

## Remote Controller

### The Power indicator does not light up.

- Has there been a power failure?
- Is the power connected properly?

### The water temperature changes after a power failure or when the power is disconnected.

- The temperature setting and the flow meter alarm setting may both need to be reset after a power outage.

### The clock display shows "- : -".

- If the time is not displayed on the clock, either a power failure has occurred or power was disconnected resulting in the display showing "- : -". (See page 10)

### The flow meter alarm does not sound or it sounds before the tub has been filled to the set amount.

- The flow meter alarm is set to sound when hot water is continuously discharged for the set volume of water.

If hot water is used for other fixtures while filling the tub, the alarm will sound before the tub is full.
- If mixing valves are used, or if cold water is mixed with hot water at the fixture, the tub will fill more than the setting of the flow meter alarm.

### The setting cannot be changed when a button is pressed.

- The Remote Controller is locked. While the Remote Controller is locked these buttons the **PROG** button, the **MENU** button, and the **▲ / ▼** buttons cannot be used. (See page 14)

### [For recirculation systems]

### Flame Indicator lights up or goes out.

- During recirculation operation, the Water Heater will turn on and off to keep the hot water pipes up to temperature.

## Temperature

### Hot water is not available when a fixture is opened.

- Are the gas and water supply valves fully open?
- Is the water supply cut off?
- Is the hot water fixture/faucet sufficiently open?
- Is the gas being cut off by the gas meter? (Can other gas devices such as stoves be used?)
- (For LP) Is there enough gas in the tank? (Can other gas devices such as stoves be used?)
- Is the water filter clogged? (See page 25)
- Is the **Power** button turned ON?

### No water is available when a fixture is opened.

- Is the water supply cut off?
- Is the Water Heater frozen?

### The hot water is not the correct temperature.

- Is the hot water fixture/faucet sufficiently open?

### Water takes time to become hot when turning the hot water fixture/faucet.

- Have you allowed enough time for the cold water in the pipes to drain out?

### The water is too hot.

- Are the gas and water supply valves fully open?
- Is the water temperature setting appropriate? (See page 12)
- If the water supply temperature is high, it is possible for the temperature to be higher than the temperature set on the Remote Controller.
- If only a small amount of hot water is demanded, it is possible for the temperature to be higher than the temperature set on the Remote Controller.

### The water is not hot enough.

- Are the gas and water supply valves fully open?
- Is the water temperature setting appropriate? (See page 12)
- If the amount of hot water required is very high, it is possible for the temperature to be lower than the temperature set on the Remote Controller. Decrease the amount of hot water passing through the Water Heater and the temperature should stabilize.

### The water is cold when only a single fixture is open.

- The unit will not heat the water if the flow rate is less than 0.29 GPM (1.1 L/min)\*.

Open the fixture more or open other fixtures so that a greater flow passes through the unit, and the unit should begin heating again.

\*Minimum activation flow rate: 0.5 GPM (2.0 L/min)  
Minimum operating flow rate: 0.29 GPM (1.1 L/min)

### Fluctuations in hot water temperatures.

- Set water temperature at 115°F to 120°F or 48°C (118°F) to 50°C (122°F). This will allow you to use a higher flow of hot water thus meeting the minimum flow requirement of 0.29 GPM (1.1 L/min)\*.
- \*Minimum activation flow rate: 0.5 GPM (2.0 L/min)  
Minimum operating flow rate: 0.29 GPM (1.1 L/min)
- Clean the water filter of any debris. (See page 25)

### Setting temperature cannot rise.

- Is the maximum temperature setting appropriate? (See page 15)

## Amount of Hot Water

### The amount of hot water at a certain fixture is not constant.

- When hot water is demanded at other fixtures, the amount available may be reduced. The maximum flow available from this Water Heater is 8.7 GPM (33 L/min) at a 45°F (25°C) temperature rise.
- Pressure fluctuations and other plumbing conditions can cause the temperature and pressure at a fixture to be unstable, but it should stabilize after a short time.
- There are some types of hot water taps that discharges large volumes of hot water at first but stabilize after time.
- To keep the temperature stable, the Water Heater limits the amount of water that can flow through it to a small amount initially, but the amount increases over time.

### The amount of hot water in the tub is less/more than the set amount.

- When hot water is used for other fixtures while filling the tub, the tub will not fill as much.
- If there is water in the tub already, or when filling is stopped and restarted, the tub will fill more.

### The flow meter alarm does not sound even when filled to the set amount.

- The flow meter alarm is set to sound when hot water is continuously discharged for the set volume of water.  
If mixing valves are used, or if cold water is mixed with hot water at the fixture, the tub will fill more than the setting of the flow meter alarm.

### Amount of hot water available has decreased over time.

- Is the water filter clogged? (See page 25)
- If the supply water is hard and has not been treated, scale can build-up in the Water Heater and decrease the maximum amount of hot water available. Scale can be removed from the Water Heater by flushing the Water Heater periodically. To prevent scale from forming in the Water Heater, a water softener or scale inhibitor is recommended.

## Sounds

**The fan can be heard after operation is stopped.  
A motor can be heard when turning the Water Heater on or off, when opening or closing a fixture, or after the Water Heater has been running for a while.**

- These noises indicate the proper operation of devices which are designed to let the Water Heater reignite more quickly, and ensure the water temperature is stable.

## Other

**The Water Heater stops burning during operation.**

- Are the gas and water supply valves fully open?
- Is the water supply cut off?
- Is the hot water fixture/faucet sufficiently open?
- Is the gas being cut off by the gas meter? (Can other gas devices such as stoves be used?)
- (For LP) Is there enough gas in the tank? (Can other gas devices such as stoves be used?)

**White smoke comes out of the exhaust vent on a cold day.**

- This is normal. The white smoke is actually steam.

**The hot water is turbid.**

- This is harmless. Small bubbles appear as the air in the water is heated and depressurized rapidly to atmospheric pressure.

**The water appears blue.**

**The tub/wash-basin has turned blue.**

- Coloration to a blue color may be noticed from small traces of copper ion contained in the water and fat (furring). However, there are not problems concerning health. Coloration of the tub/wash-basin can be prevented by cleaning frequently.

**Frequent water discharge from the condensate drain pipe.**

- Condensation forms inside the Water Heater during operation and is discharged from the condensate drain pipe.

**A small amount of water is discharged from the pressure relief valve.**

- This is normal. When the Water Heater is under high pressure, a small amount of water may be discharged from the pressure relief valve.

## Checking for Error Conditions

When a failure occurs, information relating to the error blinks on the display.

The error alarm may also continuously sound. If this occurs, take appropriate measures as following list.

[Error Code Display Screen]

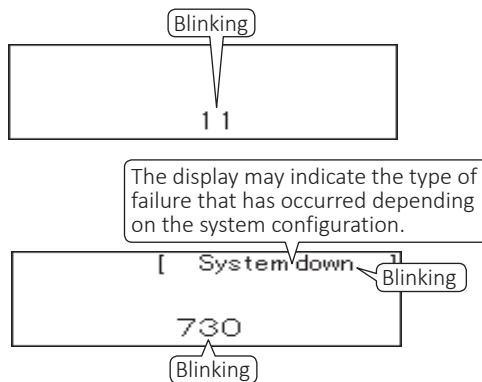

---

**Error Code : 11**

Cause : Ignition failure

Action : Check whether the gas valve is open.  
Press the **Power** button to turn the Water Heater off, open a hot water fixture/faucet, and turn the Water Heater back on. If the flashing number doesn't return the problem is solved.

---

**Error Code : 90**

Cause : [When supplying combustion air from the indoors]

The air supply vent may be clogged.

Action : Check air supply vent for blockage or obstruction. (See page 24)

Cause : Exhaust vent may be clogged.

Action : Check exhaust vent for blockage or obstruction.

Cause : Abnormal combustion, low gas supply pressure.

Action : Have a professional check the gas supply pressure.

Cause : Condensate drain line may be clogged.

Action : Check condensate drain line is clogged or frozen. If the display continues, contact nearest Noritz agent.

---

**Error Code : C1# (# = 1-9)**

Cause : Service Reminder (Notice for periodic maintenance)

Action : This Water Heater is equipped with an automatic service reminder.  
Excessive scale build-up may cause premature failure of the heat exchanger.  
Excessive dust or lint build-up in the fan and air intake may affect efficiency and combustion performance.  
Contact Noritz America for additional information about recommended maintenance procedures (1-866-766-7489).

---

**Contact Noritz America if:**

- Any other error code appears.
- An error code is indicated again after the above actions were followed.
- There are any other questions.

**Stop the Error Alarm**

Press the **ALARM OFF** button (the indicator will turn off).

# Follow-up Service

## Requesting Service

First follow the instructions in the troubleshooting section. (See pages 26-29)  
If the error is not corrected, contact Noritz America Technical Support at 1-866-766-7489.

We will need to know:

- **The Model**

Check the rating plate (See page 4 for the location of the label)

- **Date of purchase**

See the warranty

- **Details of problem**

Flashing error codes, etc., in much detail as possible

- **Your name, address, and telephone number**

- **Desired date of visit**

**NOTE** A request for service may be rejected if the Water Heater is installed in a location where working on the Water Heater may be dangerous. Contact a plumber.

## Warranty

The warranty registration information is shown on page 33 of this owner's guide. Be sure that installer name, date of purchase and other necessary information are filled in when registering your product.

Read the content carefully, and keep this owner's guide in a safe place.

For repairs after the warranty period, there will be a charge on any service, and service will only be performed if the unit is deemed repairable.

## Period of Time for Stocking Repair Parts

Noritz will stock repair and maintenance parts for this unit for the time period from the date of the original installation as follows: twelve (12) years for the heat exchanger and ten (10) years for remaining parts.

## Reinstallation

If you want to reinstall the appliance at a different location, confirm that the gas and power supply indicated on the rating plate are available at the new location. If you are not sure, consult the local utility company.

## If an error code is displayed, the model name and code can be checked

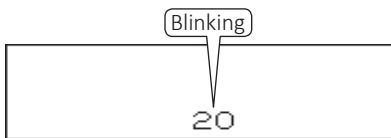

(e.g. Error Code 20)

- If more than one Water Heater is installed, this procedure cannot be used.

1. Press the **ENTER** button.

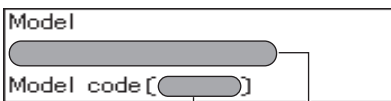

Model code  
Product name of the Water Heater is displayed

2. Press the **ENTER** button again. (Return to previous screen.)

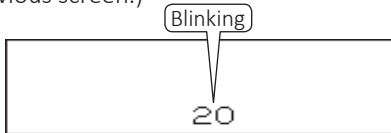

(Display Example)

- If the display is left untouched for approximately 60 seconds, it will return to the previous screen.

## Check the status of the system

1. Press the **STATUS** button inside the cover.

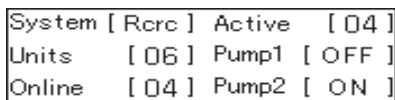

(Display Example)

- Status can be checked regardless of whether the **Power** button is ON/OFF.
- If you press the **BACK** button or it is left untouched for approximately 10 minutes, it will return to the previous screen.



2. Press the **STATUS** button inside the cover again.

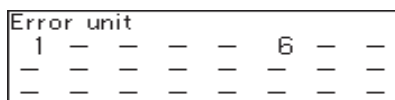

(Display Example)

- You can identify units that require service. (system dependent)
- If you press the **BACK** button, the screen returns to STEP 1.  
If you press the **STATUS** button, the screen returns to the previous screen.

## Gas Conversion

- If you move to a region that uses a different type of gas or if the local gas supply is converted, replacement of the gas manifold and adjustment of the appliance will be necessary.
- This work must be performed by either Noritz or a qualified service agency and will be charged for even during the warranty period. The qualified installer will also be responsible for purchasing the gas conversion kit directly from the manufacturer.
- For more information, contact Noritz America Technical Support at 1-866-766-7489.

### ⚠ WARNING





- The gas conversion kit shall be installed by a qualified service agency\* in accordance with the manufacturer's instructions and all applicable codes and requirements of the authority having jurisdiction.
- The information in the instructions must be followed to minimize the risk of fire or explosion or to prevent property damage, personal injury, or death.
- The qualified service agency is responsible for the proper installation of this kit.
- The installation is not proper and complete until the operation of the converted appliance is checked as specified in the manufacturer's instructions supplied with the kit.

\* A qualified service agency is any individual, firm, corporation, or company which either in person or through a representative is engaged in and is responsible for the connection, utilization, repair or servicing of gas utilization equipment or accessories; who is experienced in such work, familiar with all precautions required, and has complied with all of the requirements of the authority having jurisdiction.

1. Before the gas conversion is performed, verify the proper gas conversion kit with your Water Heater model on the table provided below.

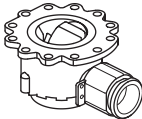
Conversion Kit	Conversion Type
CK-82	Propane to Natural Gas
CK-83	Natural Gas to Propane

2. The following parts are supplied in the conversion kit. These items will replace the existing parts that are currently installed in the Water Heater.

Venturi Mixer Set 	O-Ring (× 2) 
Conversion Kit Label 	Gas Conversion Connector*  * This connector is including in only CK-82 to convert from Propane to Natural Gas.

- NOTE**
- Make sure that all parts are replaced and properly installed by a qualified service agency.
  - A Noritz Remote Controller and a digital gas manometer are required to complete the installation. Do not proceed if this Water Heater is not immediately available.

3. After the necessary parts have been replaced on the Water Heater, the remote controller is then used to adjust the settings on the Water Heater for use with the proper gas type.
4. The following pressure value are verified by the installer.
  - The inlet gas pressure value at the gas supply inlet fitting
  - The offset pressure value at the gas valve
5. Proper adjustments will be made to ensure safe and efficient operation.
6. Once this is completed, a final gas leak check will be performed to confirm that all parts have been securely installed.

- NOTE** If you notice the smell of gas at any time after the installation has been completed, turn the Water Heater off and contact your gas supplier immediately.

# Specifications

- Specifications may be changed without prior notice.
- The capacity may differ slightly, depending on the water pressure, water supply, piping conditions, and water temperature.

Item		Specification
Model Name		NCC199CDV (GQ-C3260WZ-FF US)
Type	Installation	Indoor / Outdoor Wall mounted
	Air Supply / Exhaust	Power Vented
Ignition		Direct Ignition
Operating Pressure		15-150 psi (Recommended 50 to 80 psi for maximum performance)
Minimum Activation Flow Rate*		0.5 GPM (2.0 L/min)
Minimum Operating Flow Rate*		0.29 GPM (1.1 L/min)
Dimensions (Height) × (Width) × (Depth)		27.0 in. (687 mm) × 18.5 in. (471 mm) × 14.1 in. (359 mm)
Weight		70 lbs. (32 kg)
Water Holding Capacity		0.80 Gallon (3.0 L)
Connection Sizes	Water Inlet	NPT 3/4 in.
	Hot Water Outlet	NPT 3/4 in.
	Gas Inlet	NPT 3/4 in.
	Condensate Drain	NPT 1/2 in.
Power Supply	Supply	120 VAC (60 Hz)
	Consumption	NG: 96 W LP: 80 W Freeze Prevention: 114 W
	Maximum Current	4 Amps
Materials	Casing	•Front Cover: Hot-dipped zinc-aluminum-magnesium-alloy-coated steel w/ Polyester Coating •Casing: Zincified Steel Plate / Polyester Coating
	Flue Collar	PP
	Primary Heat Exchanger	Stainless Steel Sheeting, Stainless Steel Tubing
	Secondary Heat Exchanger	Stainless Steel Sheeting, Stainless Steel Tubing
Safety Devices		Flame Rod, High Limit Switch, Lightning Protection Device (ZNR), Freezing Prevention Device, Fan Rotation Detector
Included Accessories		Remote Controller, Remote Controller Cord, Anchoring Screws, Wall Mounting Bracket

\* Minimum flow rate may change by setting temperature and water temperature.

## Performances

Item		Performance
Gas Consumption	NG	Maximum: 199,900 Btu/h, Minimum: 18,000 Btu/h
	LP	Maximum: 199,900 Btu/h, Minimum: 18,000 Btu/h
Maximum Hot Water Capacity (45°F (25°C) Rise)		8.7 GPM (33 L/min)
Capacity Range		0.5-11.1 GPM (2-42 L/min)
Temperature Settings	°F Mode	100-150°F (In 5°F intervals), 160°F, 170°F, 185°F (14 Options)
	°C Mode	37-48°C (In 1°C intervals), 50-85°C (In 5°C intervals) (20 Options)



# Noritz America Corporation LIMITED WARRANTY - TANKLESS WATER HEATERS

**1. What is Covered by this Warranty** During the applicable Warranty Period (specified below), Noritz America Corporation (“Noritz”) warrants to the original purchaser (“Buyer”) that the new Noritz gas water heater in the originally installed location (“Product”) is free from material defects in material or workmanship (the “Warranty”). There are different Warranty Periods for different components of the Product, as described below. This Warranty is for the benefit of the original Buyer only and terminates upon transfer of the Product from the original Buyer to any other person or entity. For this Warranty to be effective (i) the Product must be installed by a method recognized and authorized by Noritz and in compliance with Noritz published materials specifically indicated in writing to be applicable to the type and model number of the Product and in compliance with instructions in the Installation Manual and Owner’s Guide, which are included with the Product (“Proper Installation”); and (ii) Buyer must use the Product in compliance with instructions in the Installation Manual and Owner’s Guide, which are included with the Product.

**2. Warranty Period** This Warranty is provided by Noritz to the Buyer for the duration of the applicable Warranty Period for the particular component of the Product as specified below. This Warranty takes effect (“Warranty Effective Date”) on the date of Proper Installation of the Product, or 30 days after the date of purchase of the Product, whichever occurs first, and is effective until the expiration of the “Warranty Period” for the particular Product component as shown below. The date of Proper Installation must be provided to Noritz as well as a copy of the original receipt for the purchase of the Product to establish the Warranty Effective Date. For example, when the Product is installed in new single-family residential construction, the Warranty Effective Date is the date upon which the Buyer takes title to the real property (e.g., the date of recordation of the deed conveying title to Buyer).

**■ Warranty Period for Heat Exchanger**

Product	Conditions		
	A) Used in a single family dwelling	B) Used in conjunction with a controlled recirculation system[1] installed in accordance with the installation manual in a single family dwelling	C) Used in a commercial capacity; used in other than a single family dwelling; supplied with pre-heated water or used in conjunction with uncontrolled recirculation
EZ98, EZ111, EZTR50 and EZTR75 (excluding EZTR40)	25 years [2]	15 years [3]	8 years [4]
NRCR92 and NRCR111	15 years [3]		8 years [4]
Residential Products with prefix “NR” 180,000 btu and higher	12 years	12 years [5]	3 years [6]
Residential Products with prefix “NR” 157,000 btu and lower, and EZTR40	12 years	3 years [6]	
NCC199CDV	25 years [2] [7]	15 years [3] [7]	10 years [8]
Commercial Products with prefix “NC” except NCC199CDV	12 years [7]	12 years [5] [7]	5 years [9]

**■ Warranty Period for Parts and Labor**

All Products	Parts other than Heat Exchanger	5 years
	Reasonable labor [10]	1 year

Footnote:

- [1] An aquastat is the minimum pump control requirement in order to maintain the full recirculation warranty. Point of use or “on demand” recirculation systems which are thermally controlled (i.e. aquastat) also classify as controlled systems.
- [2] 25 years or 15,000 operational (burn) hours, whichever occurs first.
- [3] 15 years or 12,000 operational (burn) hours, whichever occurs first.
- [4] 8 years or 12,500 operational (burn) hours, whichever occurs first.
- [5] 12 years or 6,500 operational (burn) hours, whichever occurs first.
- [6] 3 years or 4,000 operational (burn) hours, whichever occurs first.
- [7] Provided that temperature is ≤140°F. If temperature is >140°F, then applicable Warranty Period is the one used for a commercial capacity (Condition C above).
- [8] 10 years or 12,500 operational (burn) hours, whichever occurs first.
- [9] 5 years or 6,500 operational (burn) hours, whichever occurs first.
- [10] A reasonable labor rate will be paid by Noritz to service/repair professional on Noritz-approved Warranty repairs, subject to Noritz’s schedule of approved labor allowances.

**3. How do I Use this Warranty?** If Buyer discovers, within the applicable Warranty Period, a defect in material or workmanship (“Defect”), Buyer must promptly notify Noritz or its authorized representative. Please notify Noritz by contacting Noritz’s Customer Care at info@noritz.com, or by writing to Noritz Customer Care at 11160 Grace Avenue, Fountain Valley, CA 92708, or by calling Noritz Customer Care at 866-766-7489. Buyer must provide evidence of the Warranty Effective Date (See Section 2 above). Within a reasonable time after Noritz receives such notification, Noritz will ship at Noritz’s expense, either new or used/refurbished replacement parts to correct a Noritz-confirmed Defect. Buyer is responsible for any other costs, including but not limited to labor for servicing or replacing the part or Product (except to the extent that labor is covered as described in the Warranty Period section above), costs for permits or materials necessary for the repair or replacement, or incidental costs resulting from damage external to the Product resulting from the Defect. The replacement component or Product will be warranted only for the unexpired portion of the original component’s applicable Warranty Period. If during the applicable Warranty Period, the Noritz-provided new or used replacement parts, when properly installed, do not correct the Defect, or if Noritz is unable to correct the Defect after a reasonable number of attempts, Noritz will provide, at its option, one of the following: (i) a replacement new or used/refurbished Product (at Noritz’s option, either the same, comparable or better model), to be shipped at Noritz’s expense, or (ii) a full refund of the purchase price paid for the Product (excluding labor or installation costs). These remedies are the Buyer’s only remedies for breach of Warranty.

**4. What is Not Covered by this Warranty** Please refer to the Installation Manual and Owner's Guide supplied with your new Noritz Product. In addition, this Warranty becomes null and void if any of the following are determined to be contributing factors to failure of the Product under this Warranty:

- Abuse, neglect, misuse or misapplication
- Improper, dangerous, or destructive maintenance procedures
- Use in conjunction with any unapproved device
- Installation in an environment that is corrosive or otherwise destructive to the Product, whether internal or external
- Incorrect gas or water pressure
- Incorrect sizing for the application
- Use with improper gas type
- Damage as a result of freezing within the Product or surrounding piping
- Damage as a result of use with non-potable water, untreated or poorly treated well water, or water with high PH levels or hardness levels in excess of 12 grains per gallon (200 mg/L). (Please refer to the "Water Quality" section of the Owner's Guide for details)
- Damage caused by acts of God including, but not limited to; fire, flood, lightning, or natural disaster
- Damage caused by use of the Product for purposes other than those for which it was designed
- Damage caused by unauthorized attachments or modifications
- Damage resulting from improper installation of the Product
- Damage during shipment

Product purchased from any seller or retailer that is not authorized by Noritz, or any installer that obtained the Product from a distributor or supplier that is not authorized by Noritz (collectively, "Non-Authorized Product") is not covered by this Warranty and the Warranty shall be void as to such Non-Authorized Product.

**5. DISCLAIMER OF WARRANTIES** THE FOREGOING WARRANTIES ARE IN LIEU OF ALL OTHER WARRANTIES, EXPRESS OR IMPLIED, INCLUDING BUT NOT LIMITED TO THE IMPLIED WARRANTIES OF MERCHANTABILITY, FITNESS FOR A PARTICULAR PURPOSE OR NON-INFRINGEMENT. NORITZ DISCLAIMS ALL OTHER OBLIGATIONS OR LIABILITIES ON ITS PART AND NEITHER ASSUMES NOR AUTHORIZES ANY OTHER PERSON OR ENTITY TO BIND OR ASSUME FOR NORITZ ANY OTHER LIABILITIES IN CONNECTION WITH THE PERFORMANCE OF THE PRODUCT. THIS WARRANTY ONLY COVERS REPLACEMENT PRODUCT OR PARTS THEREOF, AND EXCEPT AS EXPRESSLY SET FORTH ABOVE, DOES NOT COVER THE COST OF LABOR OR SERVICES UNDER ANY CIRCUMSTANCES. SOME STATES OR PROVINCES DO NOT ALLOW LIMITATIONS ON HOW LONG AN IMPLIED WARRANTY LASTS, SO THE ABOVE LIMITATIONS MAY NOT APPLY TO YOU.

**6. LIMITATION OF REMEDIES** NORITZ'S TOTAL LIABILITY FOR ANY CLAIM ARISING HEREUNDER SHALL NOT EXCEED THE PURCHASE PRICE WHICH YOU PAID FOR THE PRODUCT. IN NO EVENT WILL NORITZ BE LIABLE FOR ANY SPECIAL, INCIDENTAL, OR CONSEQUENTIAL DAMAGES BASED ON BREACH OF WARRANTY, BREACH OF CONTRACT, NEGLIGENCE, STRICT TORT, OR ANY OTHER LEGAL THEORY. DAMAGES THAT NORITZ WILL NOT BE RESPONSIBLE FOR INCLUDE, BUT ARE NOT LIMITED TO: LOSS OF PROFITS; LOSS OF SAVINGS OR REVENUE; LOSS OF USE OF THE PRODUCT OR ANY ASSOCIATED EQUIPMENT; COST OF CAPITAL; COST OF ANY SUBSTITUTE EQUIPMENT, FACILITIES, OR SERVICES; DOWNTIME; THE CLAIMS OF THIRD PARTIES, INCLUDING CUSTOMERS; AND INJURY TO PROPERTY.

**7. Time Limit for Bringing Suit** Any action for breach of Warranty must be filed and served within 6 months following the expiration of the applicable Warranty Period with respect to the particular Product component.

**8. No Other Warranties** There are no express warranties other than those contained in this agreement. Unless modified in a writing signed by both parties, this agreement is understood to be the complete and exclusive agreement between the parties, superseding all oral or written prior agreements and all other communications between the parties relating to the subject matter of this agreement, including but not limited to statements made by salespersons. No employee or representative of Noritz, or any other person or entity, is authorized to make any warranty in addition to those made in this agreement, or to modify any warranty made in this agreement. Buyer is warned, therefore, to check this agreement carefully to see that it correctly reflects those terms that are important to the Buyer.

**9. Allocation of Risks** This agreement allocates the risks of Product failure between Noritz and the Buyer. This allocation is recognized by both parties and is reflected in the price of the goods. Buyer acknowledges that it has read this agreement, understands it, and is bound by its terms. This Warranty gives you specific legal rights, and you may also have other rights which vary from state to state or province to province.

## Warranty Registration

Register your Noritz product/s online at [www.noritz.com/warranty](http://www.noritz.com/warranty) or by calling Noritz Customer Care at 866-766-7489.

Register your Warranty online at [www.noritz.com/warranty](http://www.noritz.com/warranty)



NORITZ AMERICA CORP.  
11160 Grace Avenue  
Fountain Valley, CA 92708  
Phone: (714) 433-2905  
Fax: (714) 241-1514



